



Marking, coding and systems solutions

Cosmetics, personal and home care

 **VIDEOJET**[®]

**We know the unique challenges
you face on your production lines.**

**From managing many different
packaging types, to the ongoing
focus on brand image, Videojet
has coding solutions to help you
get your ideal code, correctly
positioned, on every product,
time after time.**

Your brands matter. Protect and enhance them with Videojet.

Whether large or small, Videojet has coding and marking solutions to meet your many production needs. Offering a wide variety of coding technologies, specialized inks and fluids, advanced software and a dedicated global service team, we can help you to code on virtually every package type and substrate.

With Videojet as your coding partner, you can enhance manufacturing flexibility with coders that do more while reducing costs and simplifying your operations.

Uptime advantage

Our extensive product line enhances the efficiency of your production lines, giving you the technologies and supplies you need to achieve optimal code quality and durability, while keeping your operations moving.

Code Assurance

Help reduce your costs and protect your brands with our innovative software solutions. These enable you to get the right code in the right place, on the right product, time after time. In fact, our innovative solutions make it virtually impossible for you to get a code wrong.

Built-in productivity

Whether you're integrating into filling lines, cartoners or any other packaging machinery, our coding solutions help enable you to maximize line efficiency and productivity while minimizing total cost of ownership.

Simple usability

Videojet products are engineered to be easy-to-use and extremely reliable. This means you can spend more time focusing on the critical aspects of your business and less time mastering our technology.



Innovative solutions for every step of your process

Filler, capper

Easy integration before, into, or after your filler is key to your coding and marking success. Videojet technology can be integrated to multiple places on your line to maximize your flexibility and code quality.

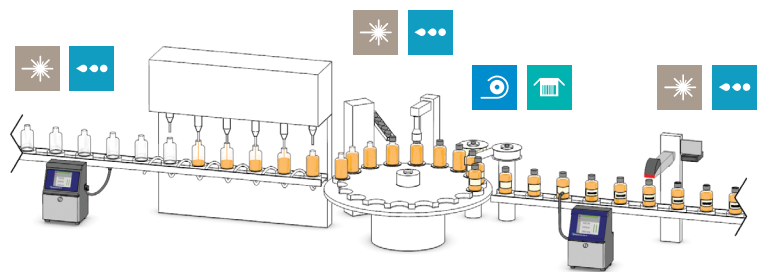

Cartoner

A range of technologies can be integrated with cartoning machines before or after packaging. Your optimal installation location will depend upon the size constraints of both your cartoner and your preferred coding technology.

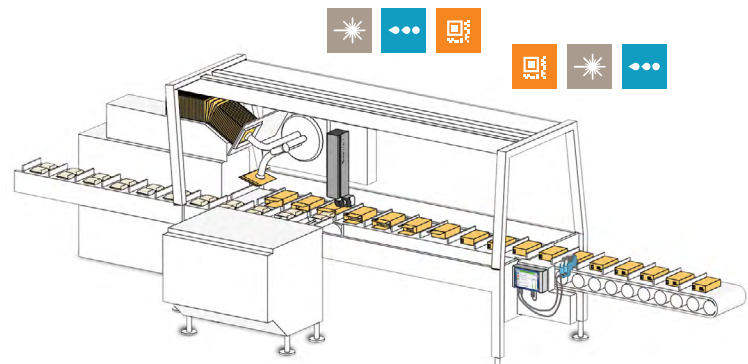

Case packers

Printers are best integrated on your conveyor after the sealed case has been discharged. The type and amount of information you want to print on your case determines which solution is best suited to your operations.

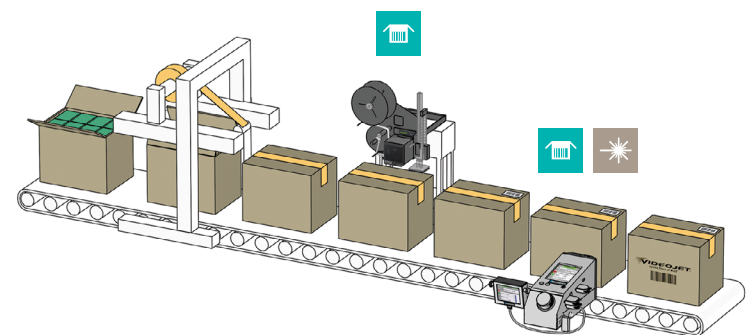

Coding technologies for your packaging type:

Printing application	CIJ	TIJ	Laser	TTO	LPA	LCM
HDPE and PET bottles, jars and containers	✓		✓	*	*	
Flexible plastic and paper	✓	✓	✓	✓	*	
Glass bottles and jars	✓		✓	*	*	
Specialty containers	✓	✓	✓	*	*	
Metal aerosol cans	✓		✓	*	*	
Folding cartons	✓	✓	✓		*	
Case		✓	✓		✓	✓

* Typically used to print on a label prior to application.

Multiple package types, six technologies, one name - Videojet

Outstanding solutions helping you mark your brands.

Cosmetics, personal and home care companies around the world choose a wide variety of packaging types to represent and differentiate their brands. Videojet offers you a full suite of coding solutions to give your brand the definition it deserves.



Continuous Inkjet (CIJ)

Fluid-based, non-contact printing of up to five lines of text, linear and 2D bar codes, or graphics, printed on a variety of packaging types including stationary packaging via traversing systems.



Thermal Inkjet (TIJ)

Ink-based, non-contact printing using heat and surface tension to move ink onto a package surface. Generally used to print 2D DataMatrix and other bar codes.



Laser Marking Systems

A beam of infrared light focused and steered with a series of carefully controlled small mirrors to create marks where the heat of the beam interacts with the packaging surface.



Thermal Transfer Overprinting (TTO)

A digitally controlled printhead precisely melts ink from a ribbon directly onto flexible films to provide high resolution, real-time prints.



Label Printer Applicator (LPA)

Prints and places labels of various sizes on multiple package types.

Large Character Marking (LCM)

Ink-based, non-contact printing of multiple data types (alphanumeric, logos and bar codes) in large sizes primarily used for shipping cases.

HDPE and PET bottles, jars and containers

Your ideal code

Over 80% of global personal and home care bottles, jars and containers are made from HDPE or PET¹.

Plastic packaging includes slick plasticizers which support plastic flexibility but can make coding difficult. So consider code contrast and resilience requirements and make sure you get product samples before you determine the optimal coding technology for your package.

Our expert sales and service teams will help you chose the right coding technology and keep it running effectively on your line.

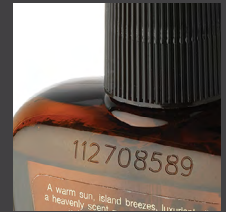

Direct to closure, package, label

Continuous Inkjet (CIJ)

- high-speed, non-contact printing, even on irregular shapes
- wide range of both dark and light colored inks for maximum contrast
- ideal for both direct-to-plastic and label printing
- mobile printhead enables code placement almost anywhere on package, including closures and curved bottoms, for maximum flexibility

Direct to closure, package, label

Laser Marking Systems

- creates clear and permanent codes that are ideal for detergents, cleaners and products used in wet environments
- no inks or fluids required, reducing your environmental footprint
- ideal for both direct-to-plastic and label printing especially in pre-printed knock-out boxes

Flexible plastic and paper

More print, less cost

Many coding technologies are effective on flexible plastic and paper packaging. While films, pouches, sleeves, and bags can all be cost-effective packaging options, managing the numerous pre-printed films for every fragrance, color and product can be challenging and costly.

Videojet has a wide range of coding technologies to give you the capability to print product information, bar codes, ingredients, logos and other information during packaging by batch, line and even individual unit. This can reduce your hassle and costs while increasing your manufacturing flexibility.



Direct to package



Thermal Transfer Overprinter (TTO)

- ideal for coding on plastic film prior to filling
- sharp bar codes and logos for clear customer communication
- perfect for adding color numbers, logos, names or bar codes on plastic sleeves

Direct to package



Direct to package



Thermal Inkjet (TIJ)

- easy to use and maintain due to the innovative no-mess ink cartridge system
- prints clear bar codes, logos and other data
- ideal for paper-based applications, such as the cardboard back of retail blister packages

Direct to package



Laser Marking Systems

- a chemical reaction on certain types of film results in a color change which gives you sharp, clear codes
- limited supplies required
- ideal for paper and some plastics

Direct to package



Continuous Inkjet (CIJ)

- specialized inks for optimized adhesion and code durability
- seamless integration into flow-wrappers, vertical form, fill and seal and other machinery
- codes on most flexible paper and plastic package types

Glass bottles and jars

Protect and enhance your brand

Defending the reputation of your business and your products is not easy. Product diversion to unauthorized channels and counterfeiting can reduce profits, tarnish brand image and create safety risks for your customers.

Our advanced coding technologies and supporting software solutions, however, can give you the supply chain control you need to prevent these threats. These solutions can be as simple as using a laser marking system to ensure a permanent code on your glass package to an integrated software solution.



Direct to glass or closure

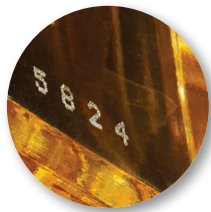

Direct to label



Direct to label and package

Continuous Inkjet (CIJ)

- print sizes available with compact 50 micron nozzles for your small, hard-to-code areas
- high contrast text ideal for customizing bottles with color numbers or names
- versatile design is easily modified for different package sizes and shapes
- UV inks enable covert coding solutions

Direct to label and package

Laser Marking Systems

- clear codes, logos and text etched into glass packaging ensures permanence and brand protection
- removal of top layer of paint on decorated bottles gives high contrast
- possible to code inside of package to prevent tampering

Direct to label

Thermal Transfer Overprint (TTO)

- prints on labels prior to placement on glass
- ribbon saving technology minimizes supply usage
- in-line print quality often on par with pre-printed content

Specialty containers

Code on almost anything

Due to their shape, use and dispensing method, many personal and home care products such as cosmetics, skin and lip care, deodorants and even air fresheners come in a variety of specialized containers. In fact, your package design often differentiates your product and can be integral to your success.

So, make sure your coding doesn't detract from your great package styling by considering coding during the design process, then choosing the optimal coding technology for your specialized package.

Videोजet's wide range of different coding technologies can help you create unique and sales winning packaging for your products.



Direct to label and package



Laser Marking Systems

- mobile CO₂ and fiber laser marking systems are easily adjusted for varying package sizes
- scribing technology and large marking fields provide excellent code quality



Direct to label



Direct to package



Direct to label



Label Printer Applicator (LPA)

- modular, robust design, which helps ensure maximum versatility
- capable of high loads, with extremely accurate control or exceptional speeds
- can be easily integrated into existing line systems

Direct to label



Thermal Transfer Overprint (TTO)

- ideal for dark packaging when a contrasting code is required
- prints on label prior to application
- many different ribbon colors available

Direct to label and package



Continuous Inkjet (CIJ)

- versatile coding solutions for almost any package material, size or color
- easy-to-use with interactive touchscreen
- Smart Cartridge™ fluid system virtually eliminates waste, mess and mistakes

Metal aerosol cans

Keep your line running

Metal aerosol cans are used around the world to dispense a variety of cosmetics, personal and home care products from polishes and cleaners, insecticides and air fresheners to deodorants, hair spray and shaving cream.

However, coding on aerosol cans can often be a challenge due to the metal finishes and curved designs. Videojet offers coding solutions and service support for these and other difficult coding applications and can help keep your line running efficiently and constantly.

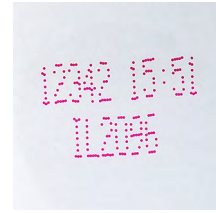

Direct to closure and package

Continuous Inkjet (CIJ)

- capable of printing on bottom of can, even with high curves
- patented CleanFlow™ technology combines a specially designed printhead and an auto cleaning function to reduce build-up and keep the printhead clean
- modular design delivers extended hours of production between scheduled maintenance

Direct to closure and package

Laser Marking Systems

- wide range of laser lenses, powers and technology types make sure that you can print on most kinds of metals and curvatures
- ideal for either engraving into the metal directly or the removal of a painted or labelled surface



Direct to closure



Direct to package



Folding cartons

Standardize and save with value-added coding

FABRICATED IN: FABRICATION: HECHO
CANADA
30.384.78712043211

Videojet coding solutions can do more than just add a batch, lot or date to your package: they can simplify your operations and help reduce your manufacturing costs.

More coding in-line and onsite means you can customize packaging at the product or batch level. With Videojet's digital coding technology you can add color names or numbers, ingredients, bar codes, or icons to your product in-line and to the outside of cartons.

Quicker changeovers and more flexible manufacturing is made possible by using coders for package customization in-line. This enables standard cartons to be used throughout a line or plant, reducing pre-printed package inventory.



Direct to packaging



Direct to package



Laser Marking Systems

- simple and clean method of marking text, bar codes or images while utilizing virtually no consumables
- A CO₂ laser will remove the top layer of a pre-printed ink to expose the layer underneath, resulting in high quality and bright contrast

Direct to package



Continuous Inkjet (CIJ)

- codes adhere to virtually all common carton materials including those with aqueous overcoats and varnishes
- reliable and cost effective coding method
- colored and pigmented inks available for dark boxes to create high contrast
- invisible UV and IR inks can hide code in package design

Direct to package



Thermal Inkjet (TIJ)

- high quality, high resolution print even after long printing breaks
- easy to integrate into packaging line for printing above or laterally

Case coding

Control your supply chain

Achieving legible and accurate information on your cases is vital for effective supply chain management. Videojet has multiple ways to help you create supply chain traceable coding, that range from high resolution printing direct to the box to automatic label application.



Direct to case



Direct to label



Direct to case



Large Character Marking (LCM)

- high resolution printing of bar codes, logos and other information
- cost-effective and dependable solutions
- eliminates the inconvenience and additional costs that can occur with labels and specialized pre-printed cases
- lower resolution valve jet option ideal for large text

Direct to case



Thermal Inkjet (TIJ)

- designed to support the GS1 DataMatrix standards
- delivers optimal time management with combination of long decap and short drying time

Direct to case



Laser Marking Systems

- permanent, durable marks and codes
- can print over large print area with a wide range of lenses
- fast marking speeds

Direct to label



Label Printer Applicator (LPA)

- high quality thermal transfer coding direct to labels
- automatic applicator offers greater speed, accuracy and error prevention than hand labelling
- easy to use design

Service, supplies and accessories

Customized solutions for your application

Every coding application is different. That is why we offer you one of the most comprehensive selections of service, supplies and accessories to customize a solution for your unique operations.

With the broadest portfolio of CIJ inks and the industry's leading team of ink application chemists, Videojet has spent over 40 years developing speciality formulations that are ideal for your personal and home care applications.

We work directly with major OEMs and have a wide range of customized accessories for all printing technologies to seamlessly integrate our printers into your production lines.



Specially developed inks and fluids

- Videojet manufactures over 640 application-unique fluids – more inks than any other industrial coding and marking manufacturer, so we are sure to have your ideal solution
- both dark and pigmented inks can enable contrast on almost all package colors
- customized accessories for almost any application



Brand protection and Code Assurance software

- specialized software works with coding equipment to help you address counterfeiting and diversion in your supply chain
- automate message creation and job selection processes to proactively prevent code errors through Code Assurance software

Service

Videojet offers global service and support with over 800 direct service and technical support resources in 24 countries and factory certified distributor support in 100 additional countries.

- Onsite installation, commissioning and operational support
- 24 X 7 help desk / technical support operations in 16 countries
- Global average onsite response time of less than 24 hours anytime of day

Service offerings can be configured to your unique needs from operator maintenance training or time material service to specialized service contracts offering part replacement, preventative maintenance and supplies.



A partner you can rely on

Videojet – accurate, reliable and cost effective printing

Continuous Inkjet (CIJ)

The most versatile of all variable technologies, CIJ prints on nearly any package type and shape. Videojet's wide range of ink colors also enable printing on almost any color.



Suggested Solutions:

Videojet 1880 Series printers combine cutting-edge features with advanced digital connectivity for a solution that's ready for a data-driven future. Delivering optimum quality and reliability, they offer crisp, clear codes that meet the need for 2D, QR, and track and trace coding, with a low-maintenance design.

Laser Marking Systems

Laser marking systems provide permanent codes which are perfect for protecting your brand and preventing counterfeiting. Without the use of ink or solvents, lasers reduce your need for additional supplies and your environmental footprint.



Suggested Solutions:

Our 10 and 30 watt CO₂ laser marking systems are versatile and easy to use. With scribing laser technology and large marking fields, they give you excellent mark quality on cartons, cases, plastic, glass and other packaging types.

Thermal Inkjet (TIJ)

This technology is ideal if you print high quality text and bar codes on cartons and paper blister packs, ensuring that even complex and detailed codes are clearly readable for your downstream partners and consumers.



Suggested Solutions:

Our Videojet TIJ coders deliver high resolution prints and bar codes on your packaging. Their compact design integrates easily into your production processes, while flexible communications and menu-driven interfaces make them easy to configure and use.



Thermal Transfer Overprinting (TTO)

Perfect for your label, plastic sleeve or flexible packaging applications, this technology gives you high quality codes and images, from date, time and ingredients to color numbers, logos and bar codes in bright colors.



Suggested Solution:

Our DataFlex® Thermal Transfer Overprinter combines high resolution printing and ribbon-saving technology for highly legible codes and minimal ribbon waste. The intuitive interface and color touchscreen make product changeovers simple and efficient.

Large Character Marking (LCM)

Make pre-printed cartons and labels unnecessary by printing your supply chain information directly on the cases, saving you time and helping to eliminate the costs and production delays associated with labels.



Suggested Solution:

Our 2380 large character inkjet printer is ideal for your high resolution case coding applications such as printing alphanumeric text, logos, images and bar codes. Through our patented micropurge process, the printhead is automatically cleaned and maintained, helping to ensure that your bar codes are scannable and your text is crisp and legible.

Label Print Applicator (LPA)

When your customers demand labels or you are using darker corrugated cases, an LPA automatically applies labels to cases to ensure high accuracy across a range of substrates.

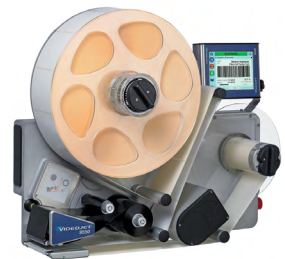

Suggested Solution:

The Videojet 9550 Label Printer Applicator is designed to be simple to use, making it extremely capable in countless applications.

Peace of mind comes as standard

Videojet Technologies is a world-leader in the product identification market, providing in-line printing, coding, and marking products, application specific fluids, and product LifeCycle Advantage™.

Our goal is to partner with our customers in the consumer packaged goods, pharmaceutical, and industrial goods industries to improve their productivity, to protect and grow their brands, and to stay ahead of industry trends and regulations. With our customer application experts and technology leadership in Continuous Inkjet (CIJ), Thermal Inkjet (TIJ), Laser Marking, Thermal Transfer Overprinting (TTO), case coding and labeling, and wide array printing, Videojet has more than 400,000 printers installed worldwide.

Our customers rely on Videojet products to print on over ten billion products daily. Customer sales, application, service and training support is provided by direct operations with over 4,000 team members in 26 countries worldwide. In addition, Videojet's distribution network includes more than 400 distributors and OEMs, serving 135 countries.

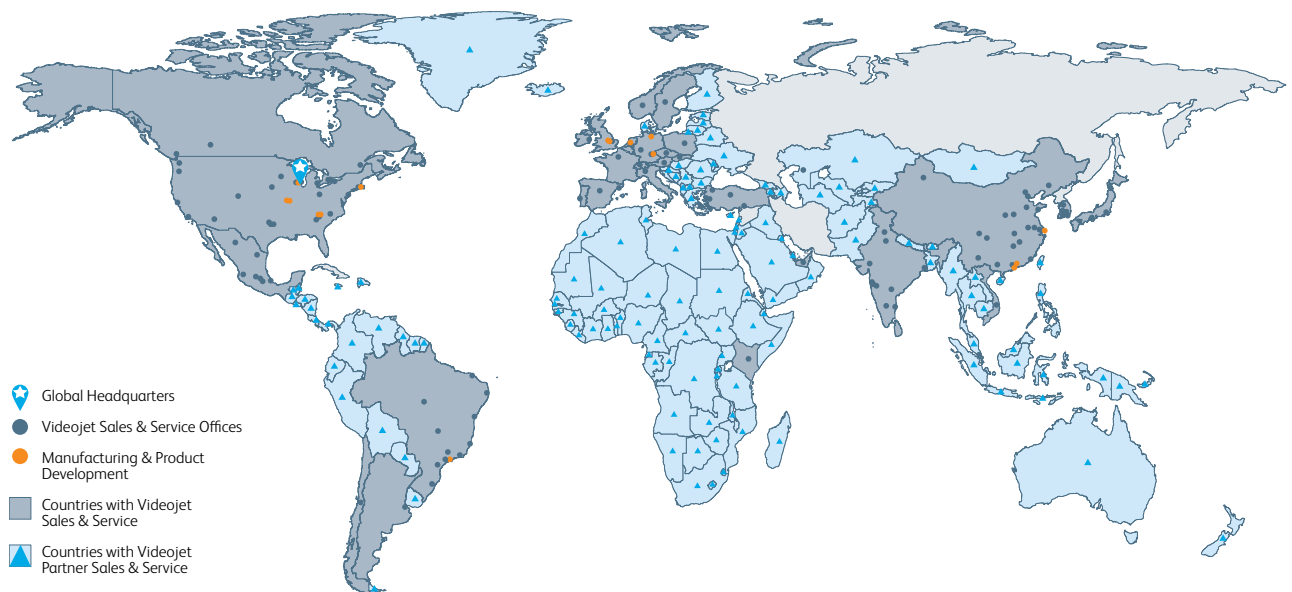

Call **800-843-3610**
Email **info@videojet.com**
or visit **www.videojet.com**

Videojet Technologies Inc.
1500 Mittel Blvd. Wood Dale IL 60191 / USA

©2024 Videojet Technologies Inc. — All rights reserved.
Videojet Technologies Inc.'s policy is one of continued product improvement.
We reserve the right to alter design and/or specifications without notice.
Part No. SL000571
br-cosmetics-personal-and-home-care-us-0724
Printed in U.S.A.

